

Russell Taylors

E-WARRANTY



SCAN HERE

Espresso Machine

www.russelltaylors.co.uk

USER MANUAL



EM-20

IMPORTANT SAFEGUARDS

Before using machine always carefully read and comply with all these instructions. We will not accept any responsibility for the consequences of improper use.

1. Warning: potential injury may result from misuse of the appliance
2. The heating element surface is subject to residual heat after use.
3. Cleaning and user maintenance shall not be made by children without supervision.
4. This appliance can be used by children aged from 8 years and above if they have been given supervision or instruction concerning use of the appliance in a safe way and if they understand the hazards involved. Cleaning and user maintenance shall not be made by children unless they are older than 8 and supervised. Keep the appliance and its cord out of reach of children aged less than 8 years.
5. Appliances can be used by persons with reduced physical, sensory or mental capabilities or lack of experience and knowledge if they have been given supervision or instruction concerning use of the appliance in a safe way and understand the hazards involved.
6. Children shall not play with the appliance.
7. Before use check that the voltage of your wall outlet corresponds to coffee maker rating plate;
8. This appliance has been incorporated with a grounded plug. Please ensure the wall outlet in your house is well

earthed.

9. Do not place the coffee maker on hot surface or beside fire.
10. Remove plug from wall outlet before cleaning and when not in use. Allow appliance to cool down completely before taking off, attaching components or before cleaning.
11. Do not operate any appliance with a damaged cord or plug or after the appliance malfunctions, or has been damaged in any manner. Return appliance to the nearest authorized service facility for examination and repair.
12. The use of accessory attachment that are not recommended by the appliance manufacturer may result in fire, electric shock, or injury to persons.
13. Place appliance on flat surface or table, do not hang its power cord over the edge of table or counter.
14. Be careful to ensure that the power cable does not become trapped and does not rub against sharp edges.
15. Ensure that the power cord does not touch hot surface of appliance;
16. Do not touch with hand directly, Use the handle of the funnel;
17. To protect against fire, electric shock and injury to persons, do not immerse appliance or power cord into water or any other liquids;
18. Do not use outdoors, It must be protected against freezing conditions;
19. Do not fill water past the MAX mark in the container.
20. Save these instructions booklet for future reference;
21. Do not immerse the machine into water.

CLEAN AND MAINTENANCE

1. The machine has to be switched off and cooled down;

2. Use a clean damp cloth to clean the stainless steel surface.

Note: Do not use abrasive sponges and alcohol or solvents.

Do not immerse the machine into water.

2. Clean the outlet and the seal ring under the group head with a soft brush;
3. Clean steam outlet and confirm there is no blockage
4. Detach the metal funnel by turning it anticlockwise, get rid of coffee residue inside, then you can clean it with cleanser, lastly running it with running water.
5. Clean all the attachments in water and dry thoroughly.
6. Clean the drip tray and removable shelf regularly then dry them.
7. Clean water tank regularly.

HOUSEHOLD USE ONLY

Accessories:

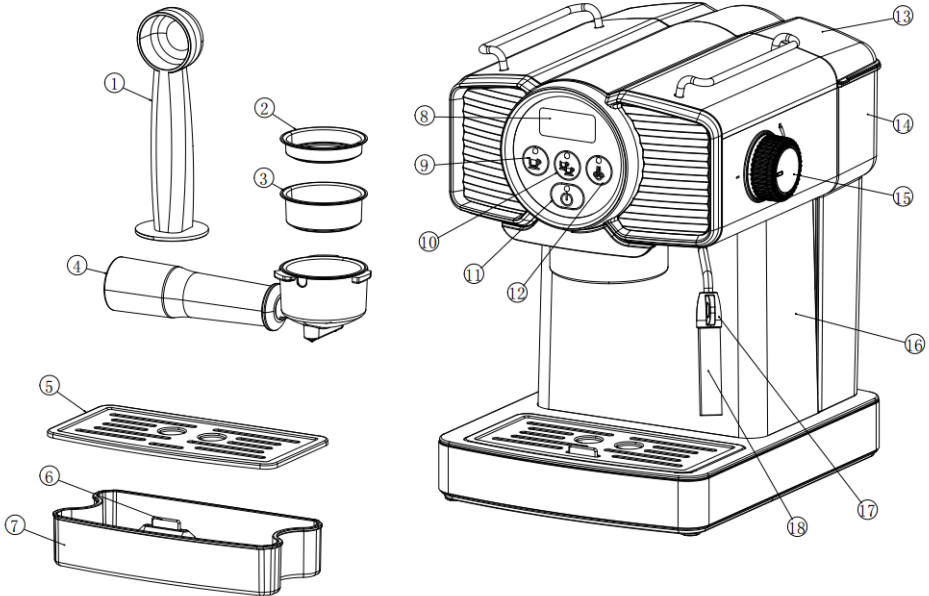

- 1.Coffee spoon 2.Single-cup coffee filter 3. Double-cup coffee filter
4.Filter holder 5.Drip tray cover 6.Buoy 7.Drip tray 8.Display screen
9.Single-cup coffee switch 10.Double-cup coffee switch 11.Power
switch 12.Steam switch 13.Water tank cover 14.Water tank
15.Steam knob 16.Main body 17.Steam pipe handle 18.Steam pipe
and nozzle



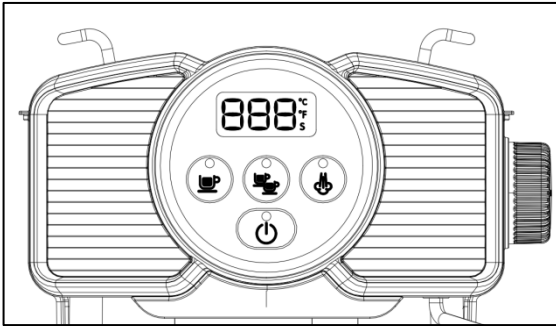

Warning: The machine must use a grinding Coffee powder and just make coffee, coffee drink(ex: Cappuccino, Latte and so on), heating milk, and other irregular use may cause danger.

Operation guide

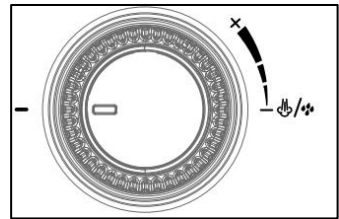







Steam knob



- "  "Power button, press the power button once to start preheating---the " " button indicator light is always on during the preheating process, " "" " "" button indicator will be flashing. After preheating, the above 3 lights will be on permanently. Press the power button again to shut down during the warm-up process or after completion.
- " "Single cup of coffee function button. Press it to start extracting coffee after preheating. Automatically it will extract the coffee until the machine stops or press the button again to stop the extraction

process. (During the extraction process, “” will flash, and the buzzer beeps when the extraction is over, and the indicator light will be turned on permanently.)



- “” Double cup of coffee function button. Press it to start extracting coffee after preheating, Automatically it will extract the coffee until the machine stops or press the button again to stop the extraction process. (During the extraction process, “” button flashes, and the buzzer beeps when the extraction is complete, and the indicator light turns on)
- “” Steam preheat button. Press this button and the indicator blinks to preheat steam. After the preheat is complete, the button ( “”) indicator light turns on .
- The steam knob: The steam knob is closed when the knob is pointing “”. There are two working states when the steam knob is turned on. When the machine is in coffee mode, the knob is turned on and the steam pipe gives hot water. When the machine is in steam mode, turn the knob and steam comes out.

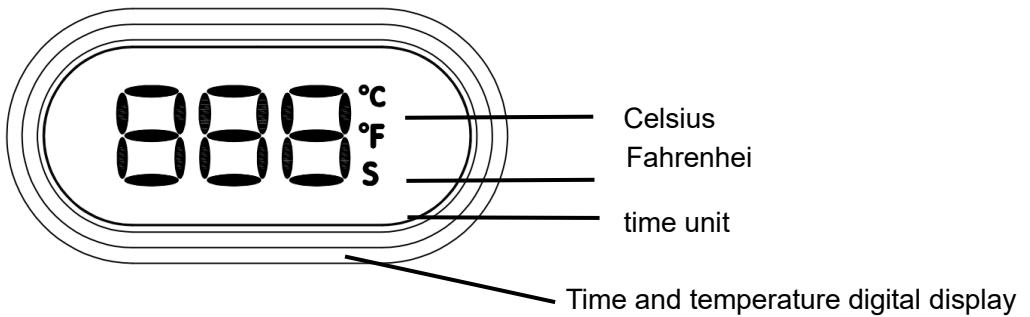

Note: When the power is turned on, the steam preheating indicator keeps flashing quickly (E-1 on the screen), this means that the steam knob is not closed, and you can turn the steam knob to the closed position .

Function display and description



1. "  "Coffee machine preheating or steam preheating process: "  "twinkle alternately;

2. "  "or"  ": After the coffee machine has been warmed up, the status is displayed in Celsius or Fahrenheit;

3. "  "or"  ": After the steam preheating is completed,

the status is displayed in Celsius or Fahrenheit;

4." ": The coffee machine enters the working state, starts to extract coffee or produce steam.

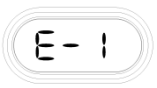
5."  "The steam knob is turned on: When the power is turned on, the steam preheating indicator keeps flashing quickly (E-1 on the screen), this means that the steam knob is not closed, and you can turn the steam knob to the closed position .

6."  "The temperature is too high: Press the coffee function key immediately after the steam is made, and an error state will appear. The solution is to wait a moment for the temperature to drop naturally or turn on the steam switch to cool down.

7."  "The temperature sensor is short-circuited or open, the temperature fuse is open, or the connection between the power board and the display board is poor. Solution: Please contact the service center.

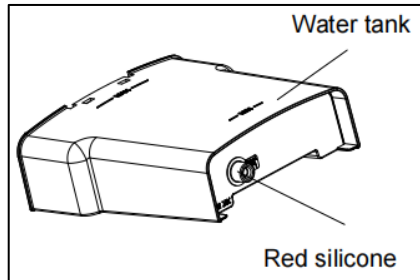

A. BEFORE THE FIRST USE (Important)

1. Move the coffee maker from the package, and check the accessories according to the list.
2. Remove the red silicone from the water tank before using the coffee maker.



3. Clean all detachable parts.
4. Fill the water tank with water and put it back on the machine, and close the water tank cover.
5. Connect the power plug, press the Power button, all indicator lamps will light on, the coffee lamps are flashing and the machine will start preheating. The preheating will be finished after 1 minute, power lamp and coffee indicator lamp will stop flashing and permanently be left on while the steam indicator light turns off.

6. Long press on "☕" "or" "☕" " for 2 seconds to enter the temperature

unit switching mode"  " Long press for 2 seconds, the temperature unit can be switched from Celsius to Fahrenheit" 

7. After the preheating is completed, turn the steam knob

counterclockwise to the maximum position, and the electromagnetic pump works until continuous hot water comes out from the steam pipe and lasts for 5 seconds (this process takes 1-2 minutes) to clean the steam pipe, and then turn off the steam switch.

8. Rotate counterclockwise to install the funnel into the funnel holder of the machine, press the "double cup coffee switch" to let hot water come out to clean the coffee filter and cup.

B. MAKE ESPRESSO COFFEE (Double-cup Coffee for example)

1. Open the lid, take out water tank, and pour appropriate water into tank. Do not exceed the MAX capacity;

2. Put back the water tank and close the lid;

3. Connect power plug, press Power button, all indicator lamp will light on and then the coffee lamps will be flashing. The machine starts preheating and will be finished after 1min. The power lamp and coffee indicator lamp will always light on and the steam indicator lamp turns off.

4. Put the coffee powder (16 to 16.5 grams) into a double filter cup. Press the powder down with the bottom of the coffee spoon. Remove the coffee powder from the sides of the filter cup.

Note: if too much coffee powder remains on the edge of the screen, it is easy to cause poor sealing and water leakage.

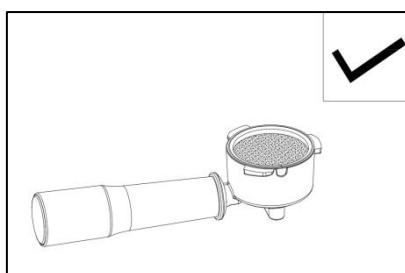
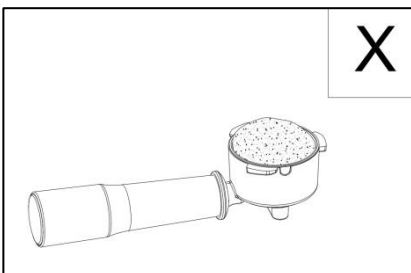

5. Rotate the high-pressure funnel assembly counterclockwise from position "☞" to position "☛" (must be tightened) ;

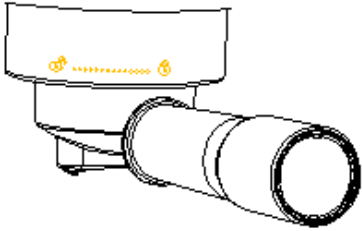

6. Put cup(s) under coffee outlet;

7. Press the double cup of coffee button, the machine starts to extract coffee, automatic extraction until the machine stops (buzzer prompt).

8. The coffee machine stops automatically (the light changes from blinking to steady on).

9. **Warning: Do not leave the coffee machine unattended during the coffee making process, as it sometimes requires manual operation.**

10. After making the coffee, turn clockwise to remove the high-pressure funnel assembly, clean the coffee grounds in the filter cup and rinse with hot water. Press a single or double coffee button and run water to rinse the coffee grounds out of the outlet.

11. When making a single cup of coffee, select a single cup of coffee filter, press the single cup of coffee switch when making, the other steps are the same as making a double cup of coffee .

Warning: Do not touch the hot surfaces of the machine with hands to avoid scald, especially brewing outlet, steam nozzle when use machine.

C. MAKE CAPPUCCINO

1. Prepare espresso first with a large enough cup according to part "B";
2. Take a special steel cup, pour in cold full fat pure milk 1/3 cup; (Can't be hot);

Note: When selecting a cup size, it is recommended that the diameter of the cup be no less than 70±5mm. As the volume of milk will increase after foaming, make sure that the cup has enough height. .

3. Press the Steam preheat button and it starts preheating,. The Single-cup, Double -cup coffee and manual coffee button indicator turn off and the steam indicator will be flashing, then wait for steam indicator lights on, now preheating finished.
4. Put an empty cup under the steam pipe, turn the "steam knob" counterclockwise to the maximum position to release a little water in the steam pipe. Then turn the "steam knob" clockwise to turn off the steam after the steam comes out.
5. Put a stainless-steel cup under steam nozzle, Let the steam pipe nozzle float below the surface of the milk;
6. Open steam knob, rotate it to the maximum position start frothing milk.
7. When desired milk foam is reached, turn off the knob to stop the steam and remove cup and pour the frothed milk into prepared espresso. .

Note: After the steam stops spraying, please clean the steam pipe assembly immediately and discharge the milk in the pipe to prevent the milk froth from scaling on the pipe wall. During the operation, due to the high surface temperature of the steam pipe, be sure not to be scalded.

INDICATOR TIPS

| Power Indicator | Single-cup Coffee Indicator | Double-cup Coffee Indicator | Steam Indicator | Display screen | Cause | Solution |
|---------------------------------|-----------------------------------|-----------------------------------|-----------------------------------|----------------------------|---|----------|
| The Red indicator blinks for 1s | The Green indicator blinks for 1s | The Green indicator blinks for 1s | The Green indicator blinks for 1s | Full display | Connect power plug | / |
| Lights on | Flashing | Flashing | Lights off | --- twinkle alternately | Coffee and hot water is pre-heating | / |
| Lights on | Lights on | Lights on | Lights off | 92°C | Coffee and hot water pre-heating finished | / |
| Lights off | Breathing light on | Lights off | Lights off | timekeeping | Making single cup coffee or water | / |
| Lights off | Lights off | Breathing light on | Lights off | timekeeping | Making double cup coffee | / |
| Lights off | Lights off | Lights off | Flashing | --- twinkle alternately | Steam is pre-heating | / |
| Lights | Lights | Lights | Lights | 130°C | Steam | / |

| | | | | | | |
|------------|------------------|------------------|--------------------|-------------|--|--|
| on | off | off | on | | pre heating finished | |
| Lights off | Lights off | Lights off | Breathing light on | timekeeping | Making steam | / |
| Lights on | Lights off | Lights off | Lights on | 130°C | Steam finished | / |
| Lights off | Lights off | Lights off | Lights off | E-3 | Temperature sensor short circuit or open circuit | Please contact with authorized service facility for repairing. |
| Lights on | Flashing quickly | Flashing quickly | Lights off | E-2 | After making the steam, touch the steam switch (the temperature is too high) | Wait temperature naturally fall or open steam button to making hot water quick cooling |
| Lights on | Lights off | Lights off | Flashing quickly | E-1 | The steam knob is not closed tightly when turning on | Tighten the steam knob |
| Lights off | Lights off | Lights off | Lights off | No display | Turn off | / |

| | | | | | | |
|------------|------------|------------|------------|------------|----------------------------------|------------------------|
| Lights off | Lights off | Lights off | Lights off | No display | Standby for more than 30 minutes | Press the Power button |
|------------|------------|------------|------------|------------|----------------------------------|------------------------|

TROUBLE SHOOTING

| Problem | Cause/Result | Solution |
|--|---|--|
| No water comes out | Water tank is empty | Fill the tank with water and turn on the steam knob until hot water comes out continuously from the steam pipe. |
| | The input voltage or frequency is inconsistent with nameplate | Make sure the voltage and frequency is consistent with the nameplate |
| | Machine malfunctions | Please contact with the authorized service |
| No steam is generated | Steam nozzle clogged | Clean steam nozzle |
| | Water tank is empty | Fill the tank with water and turn on the steam knob until hot water comes out continuously from the steam pipe, Now you can start to steam |
| | Machine malfunctions | Please contact with the authorized service |
| Coffee runs out around the edge of the filter holder | Too much powder in the filter | Turn off the machine and wait for it cool down, clean the filter, then pour appropriate coffee powder |
| | There is powder in the seal ring under group head | |
| | Implementation of the | Please contact with the |

| | | |
|--|--|---|
| | above operation problems still exist | authorized service |
| Coffee comes out too slow or no coffee comes out | coffee powder is too fine, and clogged filter | With thicker coffee powder |
| | Filter holes are blocked | Brush / clean the filter |
| | Water tank is not inserted | Insert the water tank in place |
| Water leakage on the bottom of machine | Drip tray is filled up | Please clean the drip tray |
| | Machine malfunctions | Please contact with the authorized service |
| Machine is not working | The power cord is not plugged well. | Plug the power cord into a wall outlet correctly, |
| | NTC is short circuit | Please contact with the authorized service |
| | Machine malfunctions | |
| The steam cannot froth. | Steam indicator not light on | Wait steam indicator lights on. |
| | The container is too big or the shape is not fit | Use high and narrow cup or garland cup |
| | Used skimmed milk | Use whole milk |

Russell Taylors